



## EJ..M type directional solenoid valve - 3 way / 2 positions

- Direct acting
- Spool type
- From SAE08 to SAE10 cavities

Technical specifications and diagrams are measured with mineral oil of 46 cSt viscosity at 40°C (104°F) temperature.

	EJ08M	EJ10M
Nominal flow	25 l/min (6.6 US gpm)	40 l/min (10.5 US gpm)
Max. pressure	250 bar (3600 psi)	250 bar (3600 psi)
Oil leakage	at 210 bar (3050 psi) 40 cm <sup>3</sup> /min (2.44 in <sup>3</sup> /min)	80 cm <sup>3</sup> /min (4.88 in <sup>3</sup> /min)
Fluid	mineral based oil	
Viscosity	10-200 cSt	
Max level of contamination	18/16/13 ISO4406	
Fluid temperature	with NBR seals with FPM seals	from -20°C (-4°F) to 80°C (176°F) from -20°C (-4°F) to 100°C (212°F)
Environmental temp. for working conditions	from -20°C (-4°F) to 50°C (122°F)	
Cavity	SAE 08/3	SAE 10/3
Coils type*	BER	BC16
Nominal voltages	12 VDC - 24 VDC ± 10%	12 VDC - 24 VDC ± 10%
Power rating	22.8 W (12 VDC) - 22.5 W (24 VDC)	26.1 W (12 VDC) - 25.9 W (24 VDC)
Weight	0.125 kg (0.27 lb)	0.300 kg (0.661 lb)

NOTE - For different conditions, please contact Walvoil Sales Dpt. - \*For coils further features see from page 206.

**Spool 1**

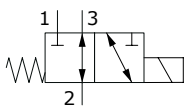

**Spool 2**

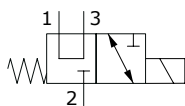

**Spool 3 (only EJ08M)**

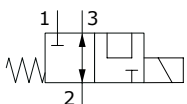

**Spool 4**

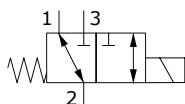

**Spool 5**

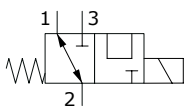

**Spool 6 (only EJ10M)**

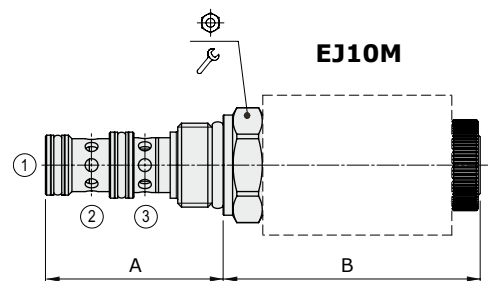
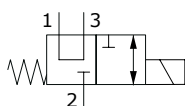

Valve type	A		B			
	mm	in	mm	in		
<b>EJ08M/10NB</b>	41.1	1.62	56.1	2.21	24	30 22
<b>EJ10M/10NB</b>	47	1.85	68	2.68	27	50 37

For dimensions with different type of emergency see page 213

### Ordering codes and description composition

EJ08M/10 NB

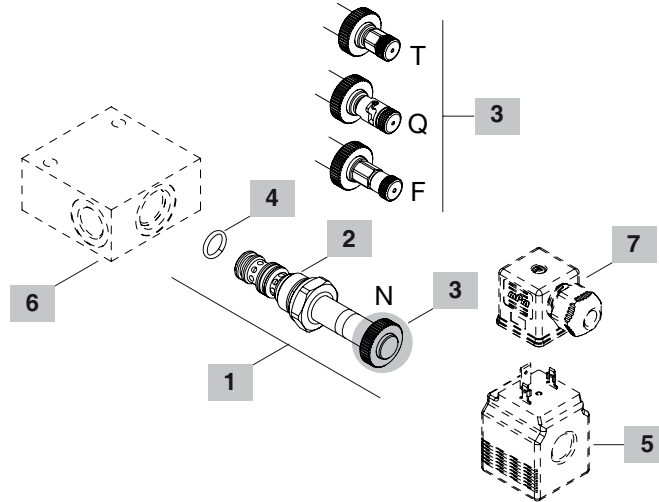
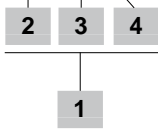

#### 1 Cartridges

TYPE	CODE	DESCRIPTION
<b>SAE cavity 08/3</b>		
EJ08M/10NB	0EJ08002030	Without emergency, spool 1
EJ08M/20NB	0EJ08002031	Without emergency, spool 2
EJ08M/30NB	0EJ08002032	Without emergency, spool 3
EJ08M/40NB	0EJ08002033	Without emergency, spool 4
EJ08M/50NB	0EJ08002034	Without emergency, spool 5
<b>SAE cavity 10/3</b>		
EJ10M/10NB	0EJ10002018	Without emergency, spool 1
EJ10M/20NB	0EJ10002019	Without emergency, spool 2
EJ10M/40NB	0EJ10002021	Without emergency, spool 4
EJ10M/50NB	0EJ10002022	Without emergency, spool 5
EJ10M/60NB	0EJ10002023	Without emergency, spool 6

#### 2 Spool

TYPE	DESCRIPTION
1	Spool 1
2	Spool 2
3	Spool 3
4	Spool 4
5	Spool 5
6	Spool 6

#### 3 Emergency

TYPE	DESCRIPTION
N	Without emergency
F	Pull button type
Q	Pull type with detent
T	Screw type

#### 4 Seals

TYPE	DESCRIPTION
B	<b>NBR (Buna)</b> o-ring seals, std configuration
V	<b>FPM (Viton)</b> o-ring seals, contact Sales Dept.

#### 5 Coils

TYPE	CODE	DESCRIPTION
BER 12VDC	4SLE001200	12VDC-ISO4400 coil for EJ08M
BC 12VDC	4SL8000120	12VDC-ISO4400 coil for EJ10M

For complete coils list see from page 206

#### 6 Valve body

TYPE	CODE	DESCRIPTION
<b>SAE 08/3-G 3/8</b>	3CC0830C11	Aluminium body for cavity 08 valve, G3/8 std thread
<b>SAE 10/3-G 3/8</b>	3CC1030C11	Aluminium body for cavity 10 valve, G3/8 std thread

Note: aluminium body can stand up to 210 bar (3050 psi)  
For steel bodies or different threading see from page 217

#### 7 Connector

TYPE	CODE	DESCRIPTION
ISO4400	4CN1009995	Connector

For complete connectors list see from page 206

**Rating diagrams**

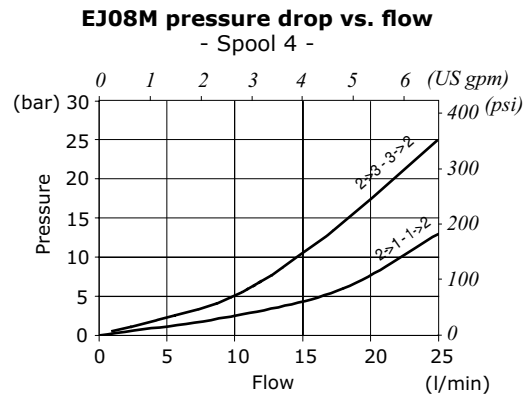
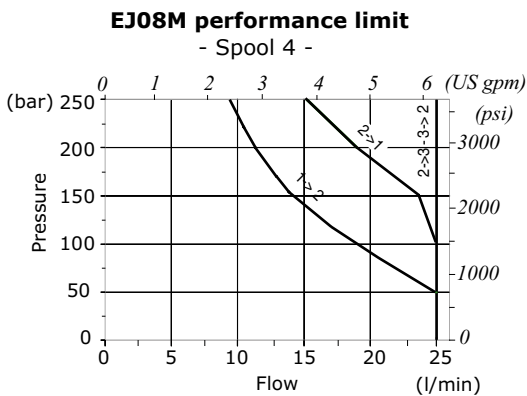
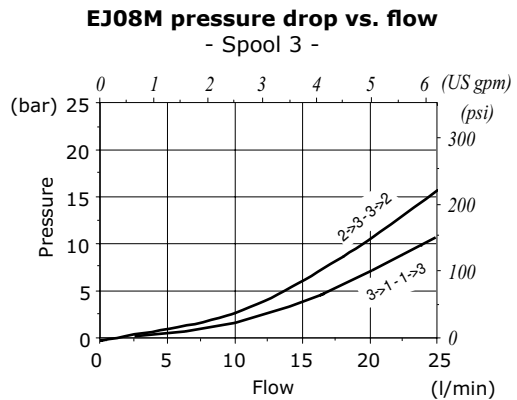
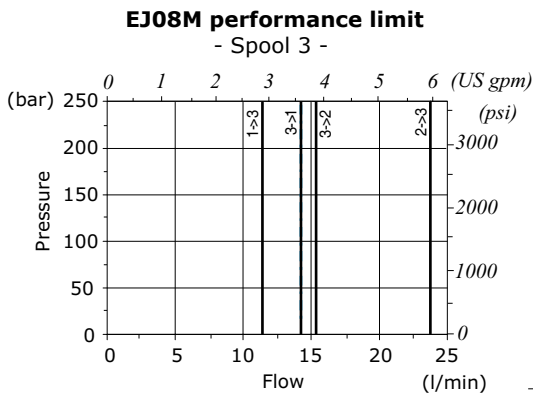
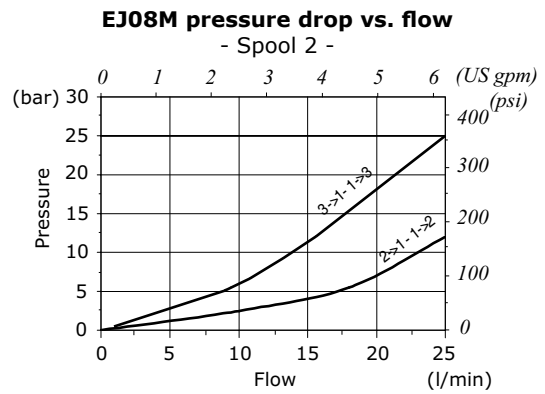
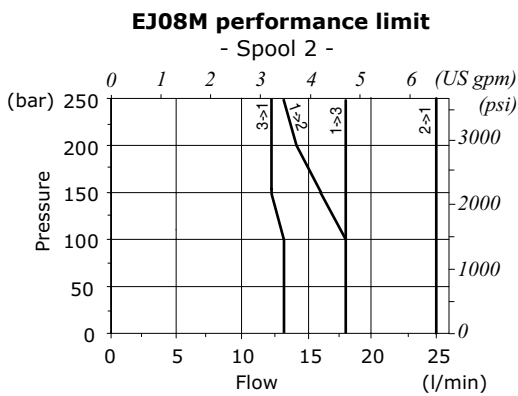
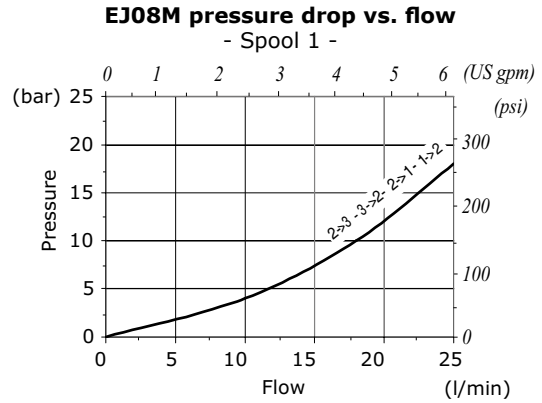
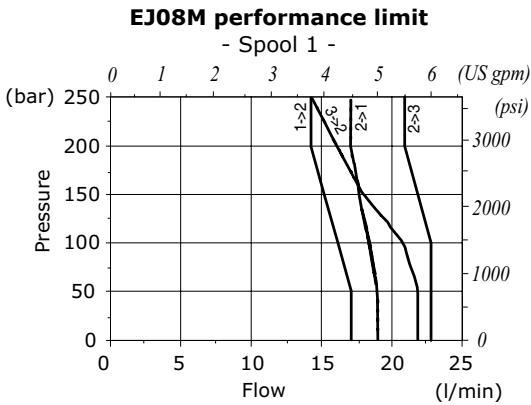

### Rating diagrams

**EJ08M performance limit**  
- Spool 5 -

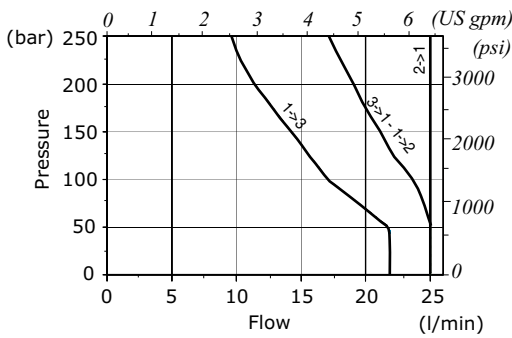

**EJ08M pressure drop vs. flow**  
- Spool 5 -

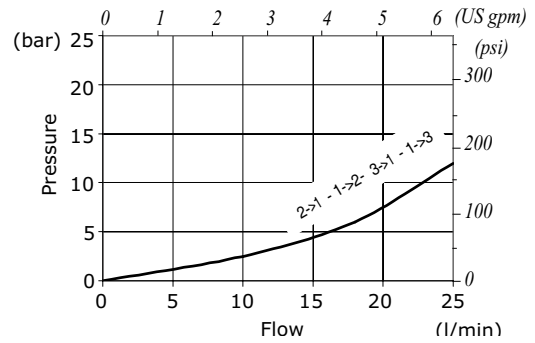

**EJ10M performance limit**  
- Spool 1 -

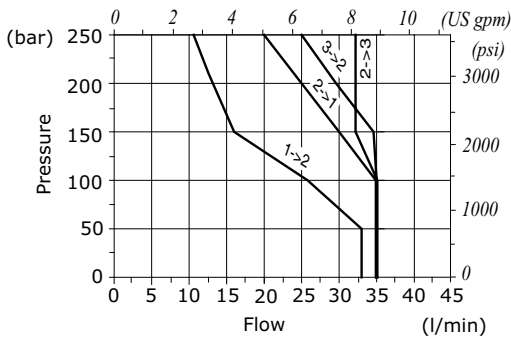

**EJ10Mp pressure drop vs. flow**  
- Spool 1 -

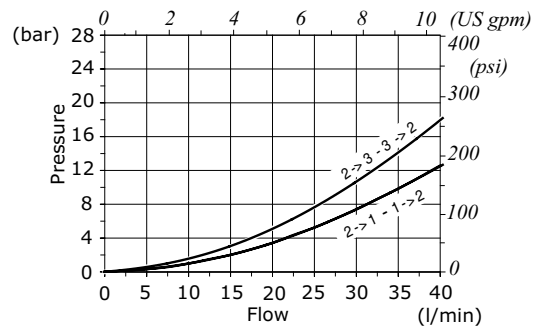

**EJ10M performance limit**  
- Spool 2 -

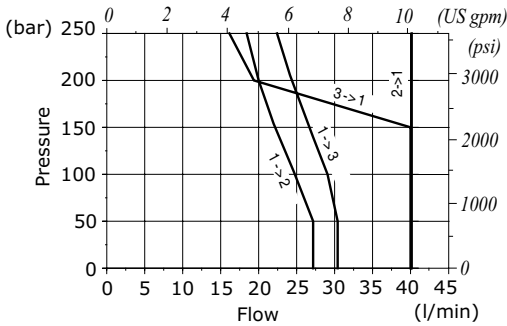

**EJ10M pressure drop vs. flow**  
- Spool 2 -

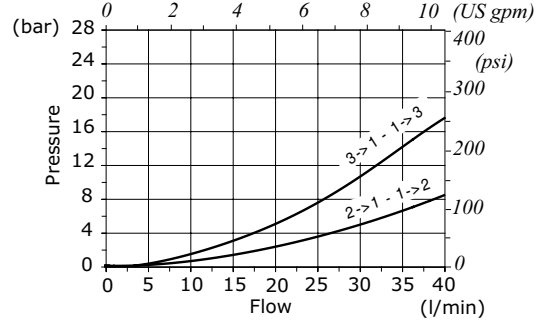

**EJ10M performance limit**  
- Spool 4 -

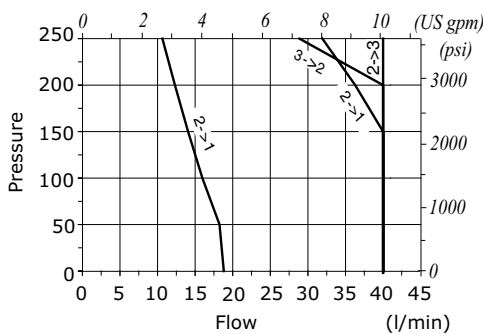

**EJ10M pressure drop vs. flow**  
- Spool 4 -

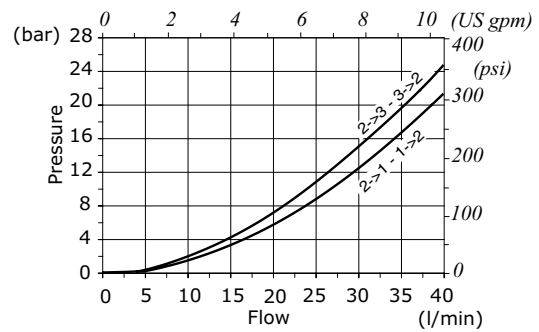

# Directional control valves

Directional solenoid valves - 3 way / 2 positions

**EJ..M type**

## Rating diagrams

**EJ10M performance limit**

- Spool 5 -

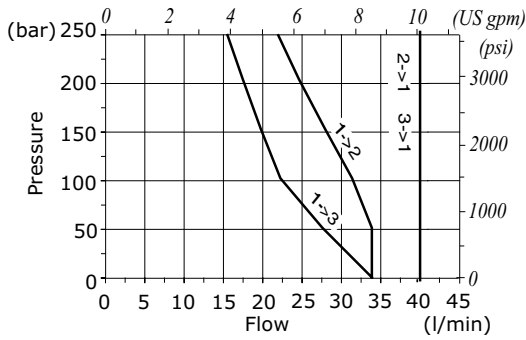

**EJ10M pressure drop vs. flow**

- Spool 5 -

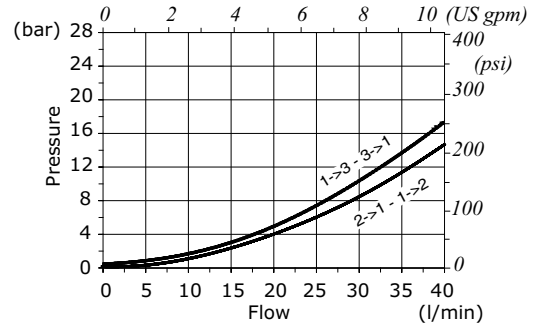

**EJ10M performance limit**

- Spool 6 -

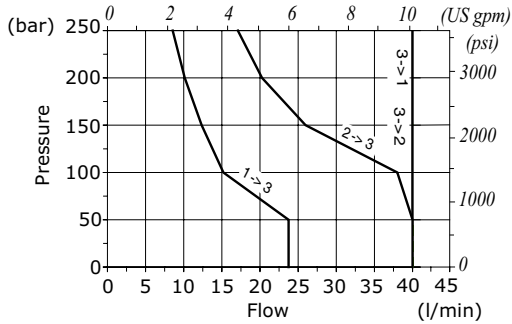

**EJ10M pressure drop vs. flow**

- Spool 6 -

