

Digital proportional flow valves

direct, pressure compensated, with on-board driver and LVDT transducer

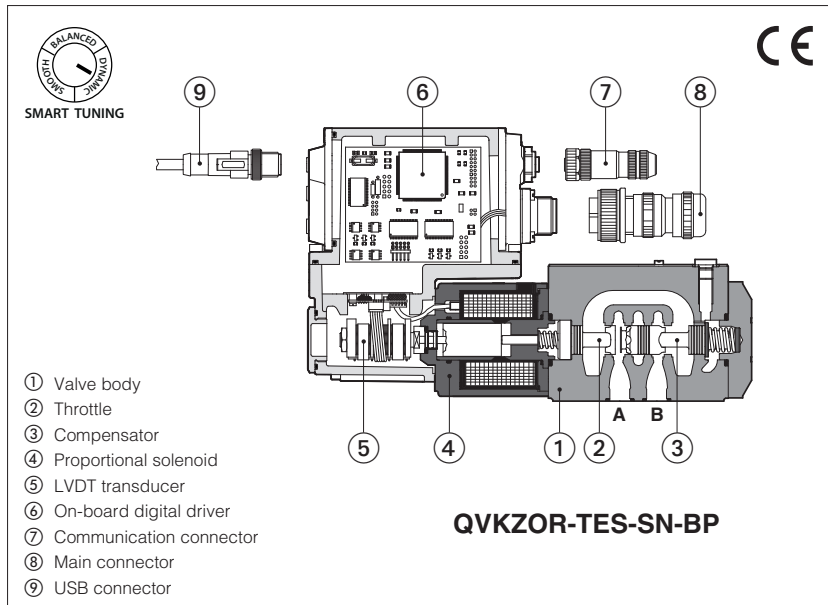

QVHZO-TEB, QVHZO-TES QVKZOR-TEB, QVKZOR-TES

Proportional flow control valves, direct, pressure compensated, equipped with LVDT position transducer for best accuracy in flow regulations.

TEB basic execution with analog reference signal and USB port for software functional parameters setting.

TES full execution which includes also optional fieldbus interfaces for functional parameters setting, reference signals and real-time diagnostics.

QVHZO:	QVKZOR:
Size: 06 - ISO 4401	Size: 10 - ISO 4401
Max flow: 45 l/min	Max flow: 90 l/min
Max pressure: 210 bar	Max pressure: 210 bar

1 MODEL CODE

QVKZOR	-	TES	-	SN	-	NP	-	10	/	65	/	*	/	*							
<p>Proportional flow control valves, direct, pressure compensated</p> <p>QVHZO = size 06 QVKZOR = size 10</p> <p>TEB = basic on-board digital driver (1) TES = full on-board digital driver</p> <p>Alternated P/Q controls: SN = none</p> <p>Fieldbus interfaces, USB port always present: NP = Not present BC = CANopen EW = POWERLINK BP = PROFIBUS DP EI = EtherNet/IP EH = EtherCAT EP = PROFINET RT/IRT</p> <p>Valve size ISO 4401: 06 = size 06 10 = size 06</p>																					
<p>Seals material, see section 10:</p> <p>- = NBR PE = FKM BT = NBR low temperature</p> <p>Series number</p>																					
<p>Electronic options (2): I = current reference input and monitor 4±20 mA (omit for std voltage and monitor 0÷10 Vdc) F = fault signal Q = enable signal Z = double power supply, enable, fault and monitor signals -12 pin connector (3)</p>																					
<p>Max regulated flow:</p> <table border="0"> <tr> <td>QVHZO:</td> <td>QVKZOR:</td> </tr> <tr> <td>3 = 3,5 l/min 36 = 35 l/min</td> <td>65 = 65 l/min</td> </tr> <tr> <td>12 = 12 l/min 45 = 45 l/min</td> <td>90 = 90 l/min</td> </tr> <tr> <td>18 = 18 l/min</td> <td></td> </tr> </table>														QVHZO:	QVKZOR:	3 = 3,5 l/min 36 = 35 l/min	65 = 65 l/min	12 = 12 l/min 45 = 45 l/min	90 = 90 l/min	18 = 18 l/min	
QVHZO:	QVKZOR:																				
3 = 3,5 l/min 36 = 35 l/min	65 = 65 l/min																				
12 = 12 l/min 45 = 45 l/min	90 = 90 l/min																				
18 = 18 l/min																					

(1) Only in version SN-NP

(2) Possible combined options: /FI, /IQ, /IZ

(3) Double power supply only for TES

2 HYDRAULIC SYMBOLS

2 way connection

3 way connection

The valves can be used in 2 or 3 way connection, depending to the application requirements.

In **2 way** the P port must not be connected (blocked)
 In **3 way** the P port has to be connected to tank or to other user lines
 The port T must be always not connected (blocked)

For application examples of 2 and 3 way connections, see section 12

3 GENERAL NOTES

Atos digital proportionals valves are CE marked according to the applicable directives (e.g. Immunity and Emission EMC Directive). Installation, wirings and start-up procedures must be performed according to the general prescriptions shown in tech table **FS900** and in the user manuals included in the E-SW-* programming software.

4 VALVE SETTINGS AND PROGRAMMING TOOLS

Valve's functional parameters and configurations, can be easily set and optimized using Atos E-SW programming software connected via USB port to the digital driver (see table **FS900**). For fieldbus versions, the software permits valve's parameterization through USB port also if the driver is connected to the central machine unit via fieldbus.

The software is available in different versions according to the driver's options (see table **GS500**):

E-SW-BASIC	support: NP (USB)	PS (Serial)	IR (Infrared)
E-SW-FIELDBUS	support: BC (CANopen)	BP (PROFIBUS DP)	EH (EtherCAT)
	EW (POWERLINK)	EI (EtherNet/IP)	EP (PROFINET)
E-SW-*/PQ	support: valves with SP, SF, SL alternated control (e.g. E-SW-BASIC/PQ)		

WARNING: drivers USB port is not isolated! For E-C-SB-USB/M12 cable, the use of isolator adapter is highly recommended for PC protection

WARNING: see tech table **GS500** for the list of countries where the Bluetooth adapter has been approved

USB or Bluetooth connection

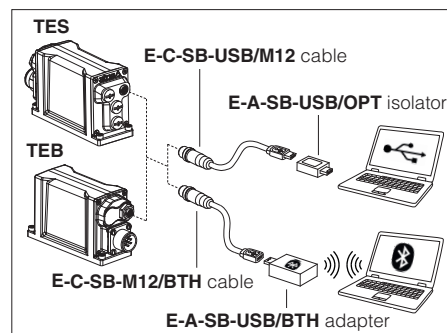

5 SMART TUNING

Smart tuning allows to adjust the valve dynamic response in order to match different performance requirements.

The valve is provided with 3 factory settings for the spool control:

- **dynamic** fast response time and high sensitivity for best dynamic performances. Default factory setting for directional valves
- **balanced** average response time and sensitivity suitable for major applications
- **smooth** attenuated response time and sensitivity to improve control stability in critical applications or in environments with electrical disturbances

Smart tuning setting can be switched from Dynamic (default) to Balanced or Smooth via software or fieldbus; if requested, performances can be further customized directly tuning each single control parameter. For details consult related manuals E-MAN-RI-* and Quickstart, see section [24](#).

6 FIELDBUS - only for TES, see tech. table **GS510**

Fieldbus allows valve direct communication with machine control unit for digital reference, valve diagnostics and settings. These execution allow to operate the valves through fieldbus or analog signals available on the main connector.

7 GENERAL CHARACTERISTICS

Assembly position	Any position
Subplate surface finishing to ISO 4401	Acceptable roughness index: Ra ≤0,8, recommended Ra 0,4 – Flatness ratio 0,01/100
MTTFd valves according to EN ISO 13849	150 years, see technical table P007
Ambient temperature range	Standard = -20°C ÷ +60°C /PE option = -20°C ÷ +60°C /BT option = -40°C ÷ +60°C
Storage temperature range	Standard = -20°C ÷ +70°C /PE option = -20°C ÷ +70°C /BT option = -40°C ÷ +70°C
Surface protection	Zinc coating with black passivation, galvanic treatment (driver housing)
Corrosion resistance	Salt spray test (EN ISO 9227) > 200 h
Compliance	CE according to EMC directive 2014/30/EU (Immunity: EN 61000-6-2; Emission: EN 61000-6-3) RoHS Directive 2011/65/EU as last update by 2015/65/EU REACH Regulation (EC) n°1907/2006

8 HYDRAULIC CHARACTERISTICS - based on mineral oil ISO VG 46 at 50 °C

Valve model	QVHZO					QVKZOR		
	[l/min]							
Max regulated flow	3,5	12	18	35	45	65	90	
Min regulated flow	15	20	30	50	60	85	100	
Regulating Δp	4 - 6		10 - 12		15	6 - 8	10 - 12	
Max flow on port A	50				60	70	100	
Max pressure	210					210		
Response time 0÷100% step signal	25					35		
Hysteresis [% of the regulated max flow]	0,5					0,5		
Linearity [% of the regulated max flow]	0,5					0,5		
Repeatability [% of the regulated max flow]	0,1					0,1		
Thermal drift	zero point displacement < 1% at ΔT = 40°C							

9 ELECTRICAL CHARACTERISTICS

Power supplies	Nominal : +24 VDC Rectified and filtered : $V_{RMS} = 20 \div 32 V_{MAX}$ (ripple max 10 % VPP)			
Max power consumption	50 W			
Max. solenoid current	QVHZO = 2,6 A		QVKZOR = 3 A	
Coil resistance R at 20°C	QVHZO = 3 \div 3,3 Ω		QVKZOR = 3,8 \div 4,1 Ω	
Analog input signals	Voltage: range ± 10 VDC (24 VMAX tollerant) Current: range ± 20 mA		Input impedance: $R_i > 50$ k Ω Input impedance: $R_i = 500$ Ω	
Monitor outputs	Output range: voltage ± 10 VDC @ max 5 mA current ± 20 mA @ max 500 Ω load resistance			
Enable input	Range: 0 \div 5 Vdc (OFF state), 9 \div 24 Vdc (ON state), 5 \div 9 Vdc (not accepted); Input impedance: $R_i > 10$ k Ω			
Fault output	Output range: 0 \div 24 Vdc (ON state > [power supply - 2 V] ; OFF state < 1 V) @ max 50 mA; external negative voltage not allowed (e.g. due to inductive loads)			
Alarms	Solenoid not connected/short circuit, cable break with current reference signal, over/under temperature, valve spool transducer malfunctions, alarms history storage function			
Insulation class	H (180°) Due to the occuring surface temperatures of the solenoid coils, the European standards ISO 13732-1 and EN982 must be taken into account			
Protection degree to DIN EN60529	IP66 / IP67 with mating connectors			
Duty factor	Continuous rating (ED=100%)			
Tropicalization	Tropical coating on electronics PCB			
Additional characteristics	Short circuit protection of solenoid's current supply; 3 leds for diagnostic; spool position control by P.I.D. with rapid solenoid switching; protection against reverse polarity of power supply			
Communication interface	USB Atos ASCII coding	CANopen EN50325-4 + DS408	PROFIBUS DP EN50170-2/IEC61158	EtherCAT, POWERLINK, EtherNet/IP, PROFINET IO RT / IRT EC 61158
Communication physical layer	not insulated USB 2.0 + USB OTG	optical insulated CAN ISO 11898	optical insulated RS485	Fast Ethernet, insulated 100 Base TX
Recommended wiring cable	LiYCY shielded cables, see section 18			

Note: a maximum time of 800 ms (depending on communication type) have be considered between the driver energizing with the 24 Vdc power supply and when the valve is ready to operate. During this time the current to the valve coils is switched to zero.

10 SEALS AND HYDRAULIC FLUIDS - for other fluids not included in below table, consult our technical office

Seals, recommended fluid temperature	NBR seals (standard) = -20°C \div +60°C, with HFC hydraulic fluids = -20°C \div +50°C FKM seals (/PE option) = -20°C \div +80°C NBR low temp. seals (/BT option) = -40°C \div +60°C, with HFC hydraulic fluids = -40°C \div +50°C		
Recommended viscosity	20 \div 100 mm ² /s - max allowed range 15 \div 380 mm ² /s		
Max fluid contamination level	normal operation	ISO4406 class 18/16/13 NAS1638 class 7	see also filter section at
	longer life	ISO4406 class 16/14/11 NAS1638 class 5	www.atos.com or KTF catalog
Hydraulic fluid	Suitable seals type	Classification	Ref. Standard
Mineral oils	NBR, FKM, NBR low temp.	HL, HLP, HLPD, HVLP, HVLDP	DIN 51524
Flame resistant without water	FKM	HF DU, HF DR	ISO 12922
Flame resistant with water	NBR, NBR low temp.	HFC	

11 DIAGRAMS - based on mineral oil ISO VG 46 at 50 °C

11.1 Regulation diagrams

- 1 = QVHZO-*-06/3
- 2 = QVHZO-*-06/12
- 3 = QVHZO-*-06/18
- 4 = QVHZO-*-06/36
- 5 = QVHZO-*-06/45
- 6 = QVKZOR-*-10/65
- 7 = QVKZOR-*-10/90

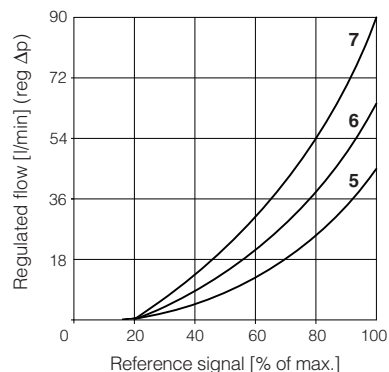
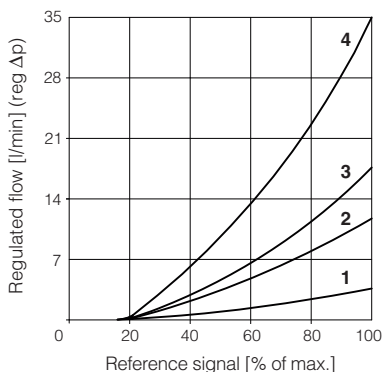

11.2 Regulated flow/outlet pressure diagrams

with inlet pressure = 210 bar

- 1 = QVHZO
- 2 = QVKZOR

Dotted line for 3-way versions

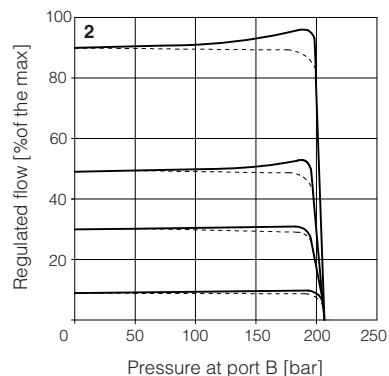
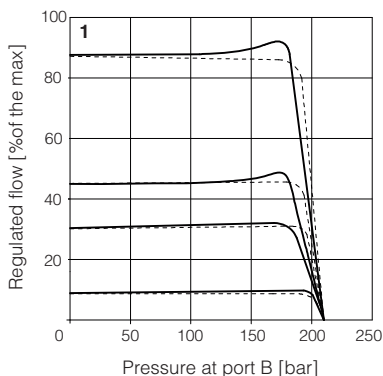

11.3 Flow A → P/Δp diagrams

3-way configuration

- 1 = QVHZO-*-06/3
- 2 = QVHZO-*-06/12
- 3 = QVHZO-*-06/18
- 4 = QVHZO-*-06/36
- 5 = QVHZO-*-06/45
- 6 = QVKZOR-*-10/65
- 7 = QVKZOR-*-10/90

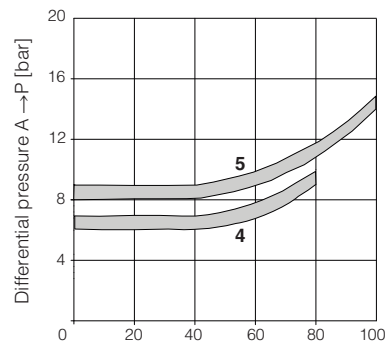
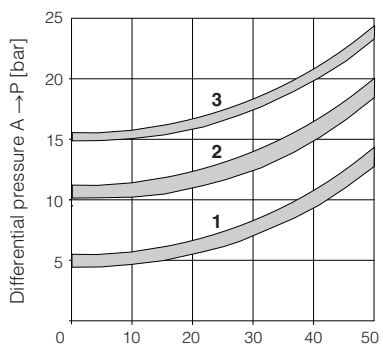

12 APPLICATIONS AND CONNECTIONS

compensated flow

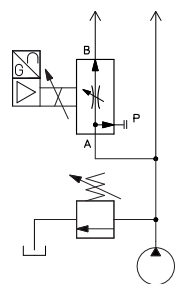

2 way connection

compensated flow

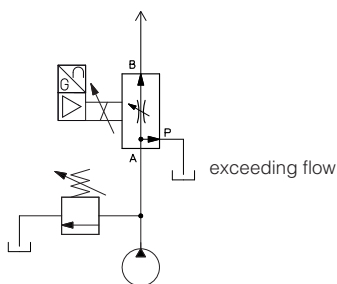

3 way connection

compensated flow
primary circuit (priority)

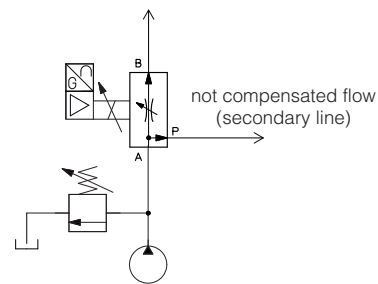

priority connection

2 way connection

The 2 way connection is normally used to control the flow in one part of the hydraulic circuit or to regulate the speed of a specific actuator. The metered flow in the controlled line is kept constant, independently to the load variations. If the valve is directly installed on the pump main line, the exceeding flow is returned to tank through the pressure relief valve.

3 way connection

The 3 way connection is normally used when the valve directly controls the pump flow (main line). The metered flow in the controlled line is kept constant, independently to the load variations. The exceeding flow (not metered by the valve) it is returned to tank through the valve P port = T line (3rd way).

Priority connection

The priority connection guarantees the pressure compensated flow supply to the primary circuit. The exceeding flow (not required by the primary circuit) is bypassed through the valve P port, to secondary circuit operating at lower pressure and not requiring compensated flow regulations.

13 ELECTRONICS OPTIONS

- F** = This option permits to monitor the eventual fault condition of the driver, as for example the solenoid short circuit/not connected, reference signal cable broken for option /I, spool position transducer broken, etc. - see 15.7 for signal specifications.
- I** = This option provides 4 ÷ 20 mA current reference and monitor signals, instead of the standard 0 ÷ 10 VDC.
Input signal can be reconfigured via software selecting between voltage and current, within a maximum range of ±10 VDC or ±20 mA.
It is normally used in case of long distance between the machine control unit and the valve or where the reference signal can be affected by electrical noise; the valve functioning is disabled in case of reference signal cable breakage.
- Q** = This option permits to inhibit the valve function without removing the power supply to the driver. Upon disable command the current to the solenoid is zeroed and the valve's spool moves to rest position.
The option /Q is suggested for all cases where the valve has to be frequently inhibited during the machine cycle – see 15.5 for signal specifications.
- Z** = This option provides, on the 12 pin main connector, the following additional features:
Fault output signal - see above option /F
Enable input signal - see above option /Q
Repeat enable output signal - only for **TEB** (see 15.6)
Power supply for driver's logics and communication - only for **TES** (see 15.2)

14 POSSIBLE COMBINED OPTIONS

/FI, /IQ, /IZ

15 POWER SUPPLY AND SIGNALS SPECIFICATIONS

Generic electrical output signals of the valve (e.g. fault or monitor signals) must not be directly used to activate safety functions, like to switch-ON/OFF the machine's safety components, as prescribed by the European standards (Safety requirements of fluid technology systems and components-hydraulics, ISO 4413).

15.1 Power supply (V+ and V0)

The power supply must be appropriately stabilized or rectified and filtered: apply at least a 10000 µF/40 V capacitance to single phase rectifiers or a 4700 µF/40 V capacitance to three phase rectifiers. In case of separate power supply see 15.2.



A safety fuse is required in series to each power supply: 2,5 A time lag fuse.

15.2 Power supply for driver's logic and communication (VL+ and VL0) - only for /Z

The power supply for driver's logic and communication must be appropriately stabilized or rectified and filtered: apply at least a 10000 µF/40 V capacitance to single phase rectifiers or a 4700 µF/40 V capacitance to three phase rectifiers.

The separate power supply for driver's logic on pin 9 and 10, allow to remove solenoid power supply from pin 1 and 2 maintaining active the diagnostics, USB and fieldbus communications.



A safety fuse is required in series to each driver's logic and communication power supply: 500 mA fast fuse.

15.3 Flow reference input signal (Q_INPUT+)

The driver controls in closed loop the valve spool position proportionally to the external reference input signal.

Reference input signal is factory preset according to selected valve code, defaults are 0 ÷ 10 VDC for standard and 4 ÷ 20 mA for /I option.

Input signal can be reconfigured via software selecting between voltage and current, within a maximum range of ±10 VDC or ± 20 mA.

Drivers with fieldbus interface can be software set to receive reference signal directly from the machine control unit (fieldbus reference).

Analog reference input signal can be used as on-off commands with input range 0 ÷ 24VDC.

15.4 Flow monitor output signal (Q_MONITOR) - not for /F

The driver generates an analog output signal proportional to the actual spool position of the valve; the monitor output signal can be software set to show other signals available in the driver (e.g. analog reference, fieldbus reference, pilot spool position).

Monitor output signal is factory preset according to selected valve code, defaults are ±10 VDC for standard and 4 ÷ 20 mA for /I option.

Output signal can be reconfigured via software selecting between voltage and current, within a maximum range of ±10 VDC or ± 20 mA.

15.5 Enable input signal (ENABLE) - not for standard and /F

To enable the driver, supply a 24 VDC on pin 3 (pin C): Enable input signal allows to enable/disable the current supply to the solenoid, without removing the electrical power supply to the driver; it is used to active the communication and the other driver functions when the valve must be disabled for safety reasons. This condition **does not comply** with norms IEC 61508 and ISO 13849.

Enable input signal can be used as generic digital input by software selection.

15.6 Repeat enable output signal (R_ENABLE) - only for TEB with /Z option

Repeat enable is used as output repeater signal of enable input signal (see 15.5).

15.7 Fault output signal (FAULT) - not for standard and /Q

Fault output signal indicates fault conditions of the driver (solenoid short circuits/not connected, reference signal cable broken for 4 ÷ 20 mA input, spool position transducer cable broken, etc.). Fault presence corresponds to 0 VDC, normal working corresponds to 24 VDC.

Fault status is not affected by the Enable input signal. Fault output signal can be used as digital output by software selection.

16 ELECTRONIC CONNECTIONS AND LEDS

16.1 Main connector signals - 7 pin - standard, /F and /Q options (A1)

PIN	Standard	/Q	/F	TECHNICAL SPECIFICATIONS	NOTES
A	V+			Power supply 24 Vdc	Input - power supply
B	V0			Power supply 0 Vdc	Gnd - power supply
C	AGND		AGND	Analog ground	Gnd - analog signal
		ENABLE		Enable (24 Vdc) or disable (0 Vdc) the valve, referred to V0	Input - on/off signal
D	Q_INPUT+			Flow reference input signal: ± 10 Vdc / ± 20 mA maximum range Defaults are 0 ÷ 10 Vdc for standard and 4 ÷ 20 mA for /I option	Input - analog signal Software selectable
E	INPUT-			Negative reference input signal for Q_INPUT+	Input - analog signal
F	Q_MONITOR referred to: AGND V0			Flow monitor output signal: ± 10 Vdc / ± 20 mA maximum range Defaults are 0 ÷ 10 Vdc for standard and 4 ÷ 20 mA for /I option	Output - analog signal Software selectable
			FAULT	Fault (0 Vdc) or normal working (24 Vdc)	Output - on/off signal
G	EARTH			Internally connected to the driver housing	

16.2 Main connector signal - 12 pin - /Z option (A2)

PIN	TEB-SN /Z	TES-SN /Z	TECHNICAL SPECIFICATIONS	NOTES
	V+		Power supply 24 Vdc	Input - power supply
1	V0		Power supply 0 Vdc	Gnd - power supply
2	ENABLE referred to: V0 VL0		Enable (24 Vdc) or disable (0 Vdc) the valve	Input - on/off signal
3				
4	Q_INPUT+		Flow reference input signal: ± 10 Vdc / ± 20 mA maximum range Defaults are 0 ÷ 10 Vdc for standard and 4 ÷ 20 mA for /I option	Input - analog signal Software selectable
5	INPUT-		Negative reference input signal for Q_INPUT+	Input - analog signal
6	Q_MONITOR referred to: AGND VL0		Flow monitor output signal: ± 10 Vdc / ± 20 mA maximum range Defaults are 0 ÷ 10 Vdc for standard and 4 ÷ 20 mA for /I option	Input - analog signal Software selectable
7	AGND		Analog ground	Output - analog signal
		NC	Do not connect	Gnd - analog signal
8	R_ENABLE		Repeat enable, output repeter signal of enable input, referred to V0	Output - on/off signal
		NC	Do not connect	
9	NC		Do not connect	
		VL+	Power supply 24 Vdc for driver's logic and communication	Input - power supply
10	NC		Do not connect	
		VL0	Power supply 0 Vdc for driver's logic and communication	Gnd - power supply
11 PE	FAULT referred to: V0 VL0		Fault (0 Vdc) or normal working (24 Vdc)	Output - on/off signal
	EARTH		Internally connected to the driver housing	

Note: do not disconnect VL0 before VL+ when the driver is connected to PC USB port

16.3 Communications connectors (B) - (C)

(B) USB connector - M12 - 5 pin always present		
PIN	SIGNAL	TECHNICAL SPECIFICATION (1)
1	+5V_USB	Power supply
2	ID	Identification
3	GND_USB	Signal zero data line
4	D-	Data line -
5	D+	Data line +

(C1) (C2) BC fieldbus execution, connector - M12 - 5 pin		
PIN	SIGNAL	TECHNICAL SPECIFICATION (1)
1	CAN_SHLD	Shield
2	not used	(C1) - (C2) pass-through connection (2)
3	CAN_GND	Signal zero data line
4	CAN_H	Bus line (high)
5	CAN_L	Bus line (low)

(C1) (C2) BP fieldbus execution, connector - M12 - 5 pin		
PIN	SIGNAL	TECHNICAL SPECIFICATION (1)
1	+5V	Termination supply signal
2	LINE-A	Bus line (high)
3	DGND	Data line and termination signal zero
4	LINE-B	Bus line (low)
5	SHIELD	

(C1) (C2) EH, EW, EI, EP fieldbus execution, connector - M12 - 4 pin		
PIN	SIGNAL	TECHNICAL SPECIFICATION (1)
1	TX+	Transmitter
2	RX+	Receiver
3	TX-	Transmitter
4	RX-	Receiver
	SHIELD	

(1) shield connection on connector's housing is recommended

(2) Pin 2 can be fed with external +5V supply of CAN interface

16.4 TEB connections layout

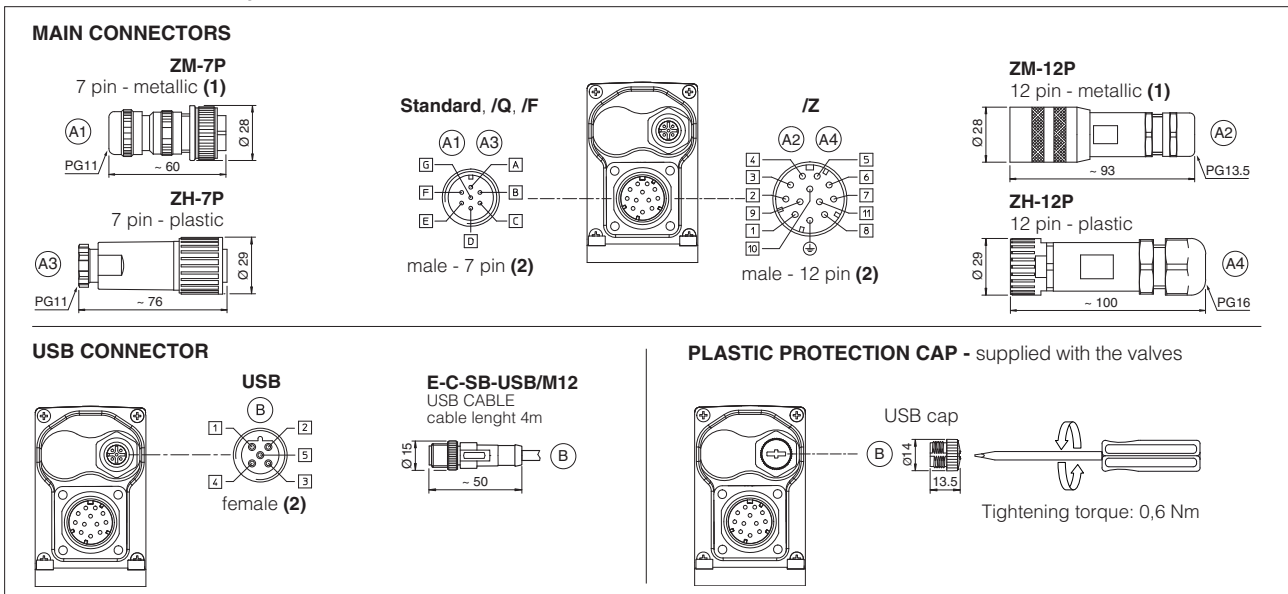

(1) Use of metallic connectors is strongly recommended in order to fulfill EMC requirements (2) Pin layout always referred to driver's view

16.5 TES connections layout

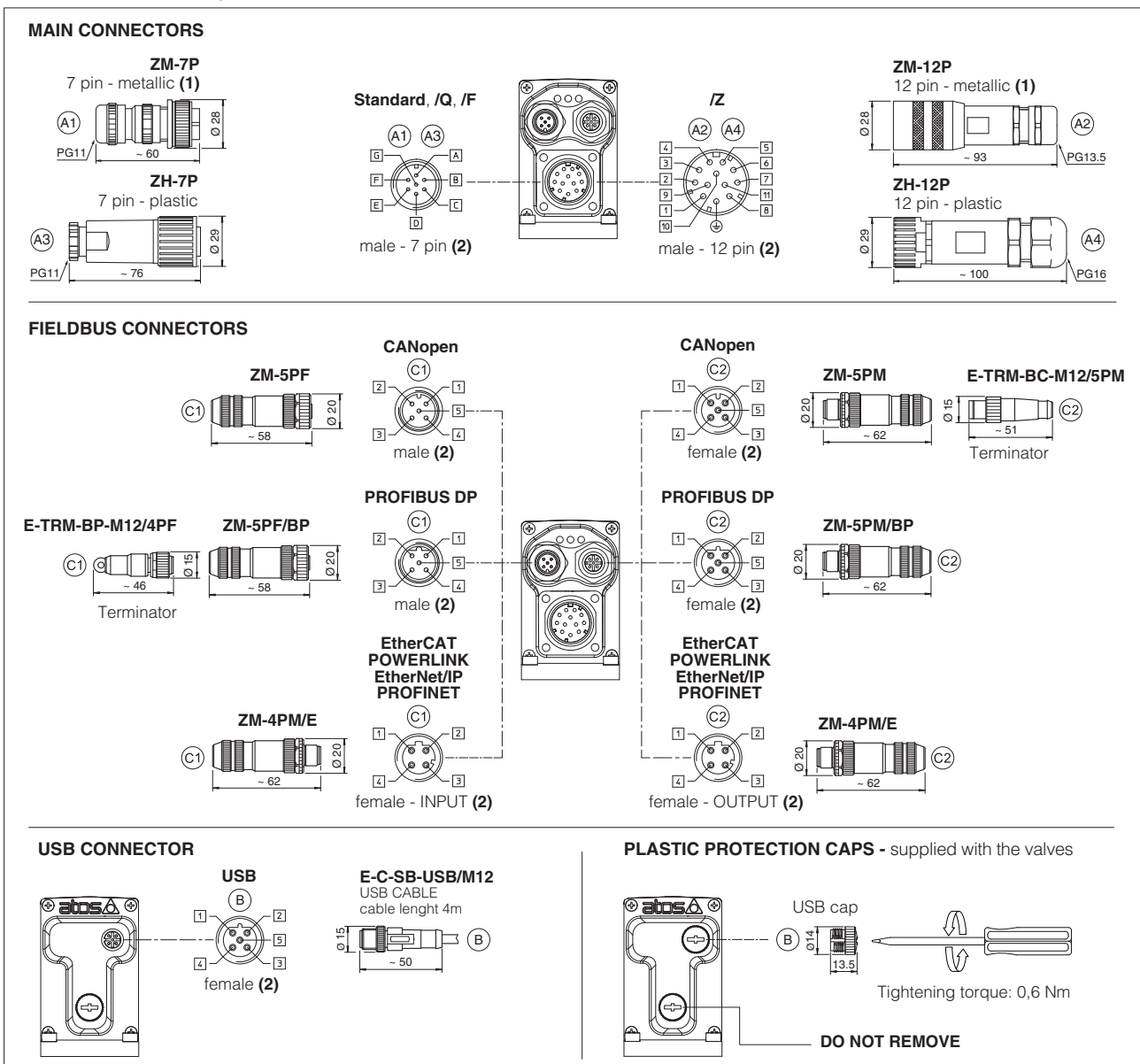

(1) Use of metallic connectors is strongly recommended in order to fulfill EMC requirements (2) Pin layout always referred to driver's view

16.6 Diagnostic LEDs - only for TES

Three leds show driver operative conditions for immediate basic diagnostics. Please refer to the driver user manual for detailed information.

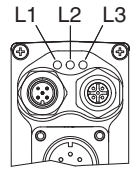
FIELDBUS LEDS	NP Not Present	BC CANopen	BP PROFIBUS DP	EH EtherCAT	EW POWERLINK	EI EtherNet/IP	EP PROFINET	
L1		VALVE STATUS		LINK/ACT				
L2		NETWORK STATUS		NETWORK STATUS				
L3		SOLENOID STATUS		LINK/ACT				

17 IN / OUT FIELDBUS COMMUNICATION CONNECTORS

Two fieldbus communication connectors are always available for digital drivers executions BC, BP, EH, EW, EI, EP. This features allows considerable technical advantages in terms of installation simplicity, wirings reduction and also avoid the usage expensive T-connectors.

For BC and BP executions the fieldbus connectors have an internal pass-through connection and can be used like end point of the fieldbus network, using an external terminator (see tech table **GS500**).

For EH, EW, EI and EP executions the external terminators are not required: each connector is internally terminated.

BC and BP pass-through connection

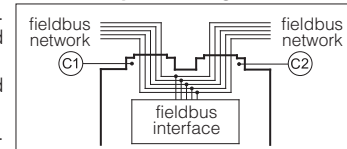

18 CONNECTORS CHARACTERISTICS - to be ordered separately

18.1 Main connectors - 7 pin

CONNECTOR TYPE	POWER SUPPLY	POWER SUPPLY
CODE	(A1) ZM-7P	(A3) ZH-7P
Type	7pin female straight circular	7pin female straight circular
Standard	According to MIL-C-5015	According to MIL-C-5015
Material	Metallic	Plastic reinforced with fiber glass
Cable gland	PG11	PG11
Recommended cable	LiYCY 7 x 0,75 mm ² max 20 m (logic and power supply) or LiYCY 7 x 1 mm ² max 40 m (logic and power supply)	LiYCY 7 x 0,75 mm ² max 20 m (logic and power supply) or LiYCY 7 x 1 mm ² max 40 m (logic and power supply)
Conductor size	up to 1 mm ² - available for 7 wires	up to 1 mm ² - available for 7 wires
Connection type	to solder	to solder
Protection (EN 60529)	IP 67	IP 67

18.2 Main connectors - 12 pin

CONNECTOR TYPE	POWER SUPPLY	POWER SUPPLY
CODE	(A2) ZM-12P	(A4) ZH-12P
Type	12pin female straight circular	12pin female straight circular
Standard	DIN 43651	DIN 43651
Material	Metallic	Plastic reinforced with fiber glass
Cable gland	PG13,5	PG16
Recommended cable	LiYCY 12 x 0,75 mm ² max 20 m (logic and power supply)	LiYCY 10 x 0,14mm ² max 40 m (logic) LiYY 3 x 1mm ² max 40 m (power supply)
Conductor size	0,5 mm ² to 1,5 mm ² - available for 12 wires	0,14 mm ² to 0,5 mm ² - available for 9 wires 0,5 mm ² to 1,5 mm ² - available for 3 wires
Connection type	to crimp	to crimp
Protection (EN 60529)	IP 67	IP 67



18.3 Fieldbus communication connectors

CONNECTOR TYPE	BC CANopen (1)		BP PROFIBUS DP (1)		EH EtherCAT, EW POWERLINK, EI EtherNet/IP, EP PROFINET (2)	
CODE	(C1) ZM-5PF	(C2) ZM-5PM	(C1) ZM-5PF/BP	(C2) ZM-5PM/BP	(C1) (C2) ZM-4PM/E	
Type	5 pin female straight circular	5 pin male straight circular	5 pin female straight circular	5 pin male straight circular	4 pin male straight circular	
Standard	M12 coding A – IEC 61076-2-101		M12 coding B – IEC 61076-2-101		M12 coding D – IEC 61076-2-101	
Material	Metallic		Metallic		Metallic	
Cable gland	Pressure nut - cable diameter 6÷8 mm		Pressure nut - cable diameter 6÷8 mm		Pressure nut - cable diameter 4÷8 mm	
Cable	CANbus Standard (DR 303-1)		PROFIBUS DP Standard		Ethernet standard CAT-5	
Connection type	screw terminal		screw terminal		terminal block	
Protection (EN 60529)	IP67		IP 67		IP 67	

(1) E-TRM-** terminators can be ordered separately - see tech table **GS500**

(2) Internally terminated

19 FASTENING BOLTS AND SEALS

	QVHZO	QVKZOR
	Fastening bolts: 4 socket head screws M5x50 class 12.9 Tightening torque = 8 Nm	Fastening bolts: 4 socket head screws M6x40 class 12.9 Tightening torque = 15 Nm
	Seals: 4 OR 108; Diameter of ports A, B, P, T: Ø 7,5 mm (max)	Seals: 5 OR 2050; Diameter of ports A, B, P, T: Ø 11,2 mm (max)

QVHZO-TEB, QVHZO-TES

ISO 4401: 2005

Mounting surface: 4401-03-02-0-05 (see tab. P005)

Mass [kg]	
QVHZO-*	2,3

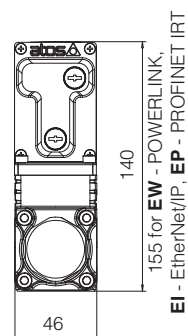
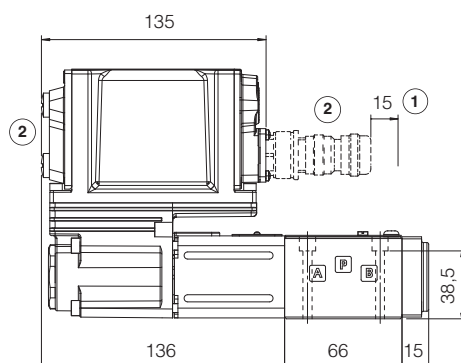

QVKZOR-TEB, QVKZOR-TES

ISO 4401: 2005

Mounting surface: 4401-05-04-0-05 (see tab. P005)

Mass [kg]	
QVKZOR-*	4,3

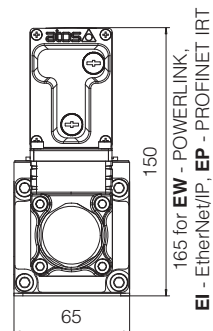
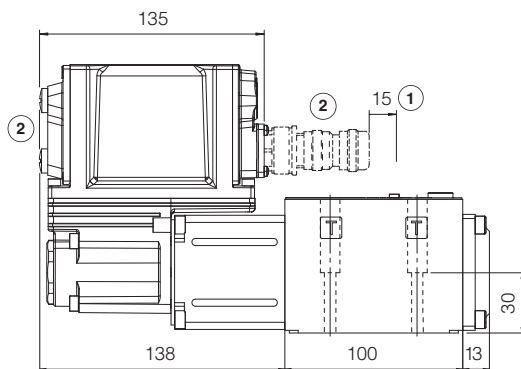

Mass: 4,3 kg

① = Space to remove the connectors

② = The dimensions of all connectors must be considered, see section 16.4 and 16.5

21 RELATED DOCUMENTATION

FS001	Basics for digital electrohydraulics
FS900	Operating and maintenance information for proportional valves
GS500	Programming tools
GS510	Fieldbus
K800	Electric and electronic connectors

P005	Mounting surfaces for electrohydraulic valves
QB300	Quickstart for TEB valves commissioning
QF300	Quickstart for TES valves commissioning
E-MAN-RI-LEB	TEB/LEB user manual
E-MAN-RI-LES	TES/LES user manual